

Data Sheet



Article number: 20612523

Description: E+G indexing mechanism
GN 200-44-K10-AS

Measures

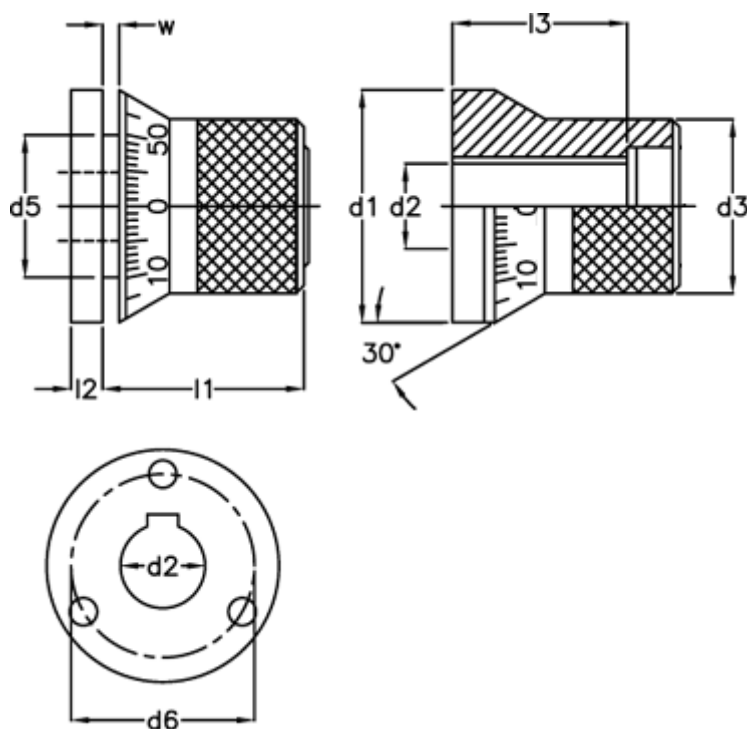

d1 = 44

W = 4

d2 = K10

d3 = 33

d5 = 23.0

d6 = 33.0

l1 = 37.0

l2 = 6

l3 = 31.0